

1 April 2026

**Enquiries:** Rebecca Taranto  
**Our Ref:** BW 2026\_5912/1 (Doc ID): 1358925  
**Your Ref:**

Administration Office  
64 - 66 Front St Mossman  
P 07 4099 9444  
F 07 4098 2902

D C Mahoney  
4069 Captain Cook Highway  
Wangetti QLD 4877

Dear Sir/Madam

**Development Application for Building Work Assessable Against the Planning Scheme-  
Two New Carports and Demolition of Shed  
At 4069 Captain Cook Highway Wangetti  
On Land Described as Lot 12 on NR7187**

Please find attached the Decision Notice for the above-mentioned development application.

Please quote Council's application number: BW 2026\_5912/1 in all subsequent correspondence relating to this development application.

Should you require any clarification regarding this, please contact Rebecca Taranto on telephone 07 4099 9444.

Yours faithfully



**For**  
**Leonard Vogel**  
**Manager Environment & Planning**

encl.

- Decision Notice
  - Approved Drawing(s) and/or Document(s)
  - Reasons for Decision - response to properly made submissions.
- Advice For Making Representations and Appeals (Decision Notice)



## Decision Notice

### Approval (with conditions)

*Given under s 63 of the Planning Act 2016*

#### Applicant Details

Name: D C Mahoney  
Postal Address: 4069 Captain Cook Highway  
Wangetti QLD 4877  
Email: deantalk@iig.com.au

#### Property Details

Street Address: 4069 Captain Cook Highway Wangetti  
Real Property Description: Lot 12 on NR7187  
Local Government Area: Douglas Shire Council

#### Details of Proposed Development

Development Permit for Building Work Assessable Against the Planning Scheme (Two New Carports and Demolition of Shed)

#### Decision

Date of Decision: 1 April 2026  
Decision Details: Approved (subject to conditions)

#### Approved Drawing(s) and/or Document(s)

Copies of the following plans, specifications and/or drawings are enclosed.

The term 'approved drawing(s) and/or document(s) or other similar expressions means:

Drawing or Document	Reference	Date
Site Plan	Sheet 1 of 7	February 2026
Exiting Surveyed Platform Area Proposed Carport on Surveyed Area	Sheet 2 of 7	February 2026
Front Elevation	Sheet 3 of 7	February 2026

Existing Shed/Skillion Floor Plan Proposed Floor Plan		
Slab/Footing Plan Roof Framing Plan	Sheet 4 of 7	February 2026
Typical Section, Side Elevation and Section	Sheet 5 of 7	February 2026
Rood Framing Plan, Footing Plan	Sheet 6 of 7	February 2026
Typical Section, South -East Elevation, South-West Elevation	Sheet 7 of 7	February 2026

### **Assessment Manager Conditions & Advices**

---

1. Carry out the approved development generally in accordance with the approved drawing(s) and/or document(s), and in accordance with:
  - a. The specifications, facts and circumstances as set out in the application submitted to Council; and
  - b. The following conditions of approval and the requirements of Council's Planning Scheme and the FNQROC Development Manual.

Except where modified by these conditions of approval.

#### **Timing of Effect**

2. The conditions of the Development Permit must be effected prior to endorsement of the Survey Plan except otherwise nominated in these conditions of approval.

#### **Building Colours**

3. The exterior finishes and colours of buildings and structures are non-reflective and are moderately dark to darker shades of grey, green, blue and brown.

#### **Advice**

1. All building site managers must take all action necessary to ensure building materials and / or machinery on construction sites are secured immediately following the first cyclone watch and that relevant emergency telephone contacts are provided to Council officers, prior to commencement of works.
2. This approval does not negate the requirement for compliance with all other relevant Council Local Laws and other statutory requirements.
3. For information relating to the *Planning Act 2016* log on to <https://planning.dsdmip.qld.gov.au/>. To access the *FNQROC Regional Development Manual*, Local Laws, the Douglas Shire Planning Scheme and other applicable Policies log on to [www.douglas.qld.gov.au](http://www.douglas.qld.gov.au).

### **Further Development Permits**

---

Please be advised that the following development permits are required to be obtained before the development can be carried out:

- All Building Work

All Plumbing and Drainage Work must only be carried in compliance with the Queensland *Plumbing and Drainage Act 2018*.

## **Currency Period for the Approval**

---

This approval, granted under the provisions of the *Planning Act 2016*, shall lapse two (2) years from the day the approval takes effect in accordance with the provisions of Section 85 of the *Planning Act 2016*.

## **Rights to make Representations & Rights of Appeal**

---

The rights of applicants to make representations and rights to appeal to a Tribunal or the Planning and Environment Court against decisions about a development application are set out in Chapter 6, Part 1 of the *Planning Act 2016*.

A copy of the relevant appeal provisions is attached.





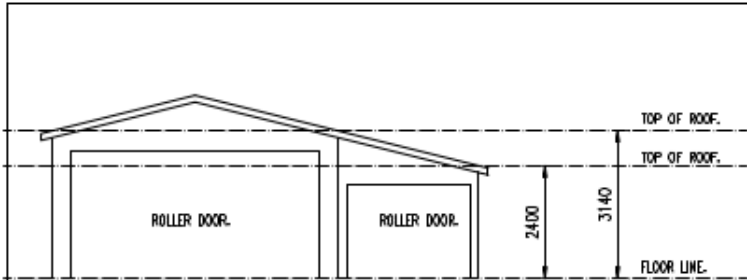

FRONT ELEVATION.

SCALE :- 1:100

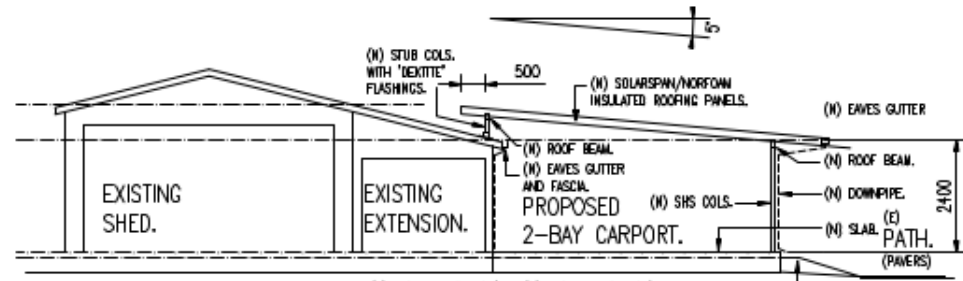

FRONT ELEVATION.

SCALE :- 1:100

NOTE:-  
PROPOSED REAR ELEVATION  
SIMILAR.

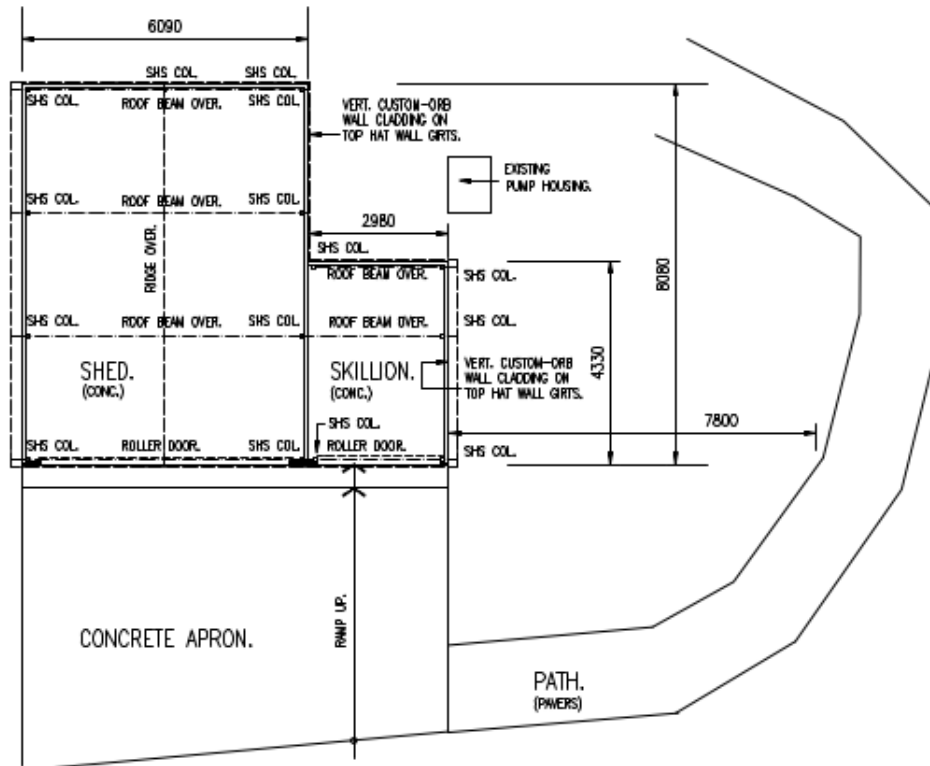

'EXISTING' SHED/SKILLION  
FLOOR PLAN.

SCALE :- 1:100

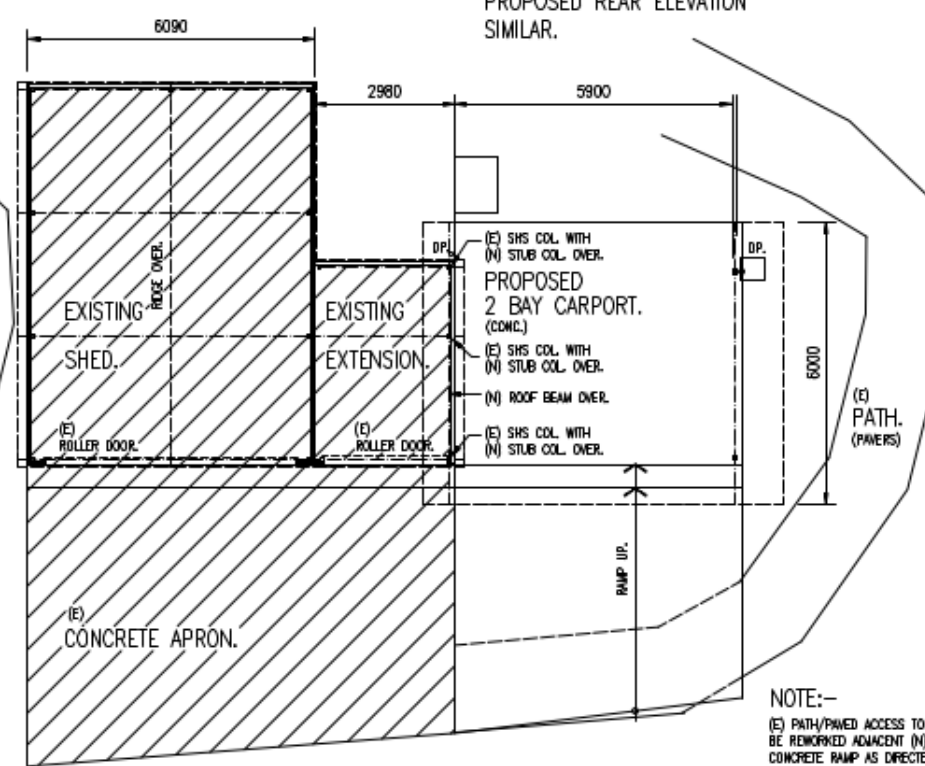

'PROPOSED'  
FLOOR PLAN.

SCALE :- 1:100

NOTE:-  
NEW 100W UPVC DOWNPIPES  
TO DISCHARGE ON TO GROUND  
OVER 500 X 500 X 100 CONCRETE  
SPLASHPADS.  
EXACT LOCATION AND DISCHARGE OF  
DOWNPIPES TO BE DETERMINED ON SITE.

SHEET 3 OF 7.



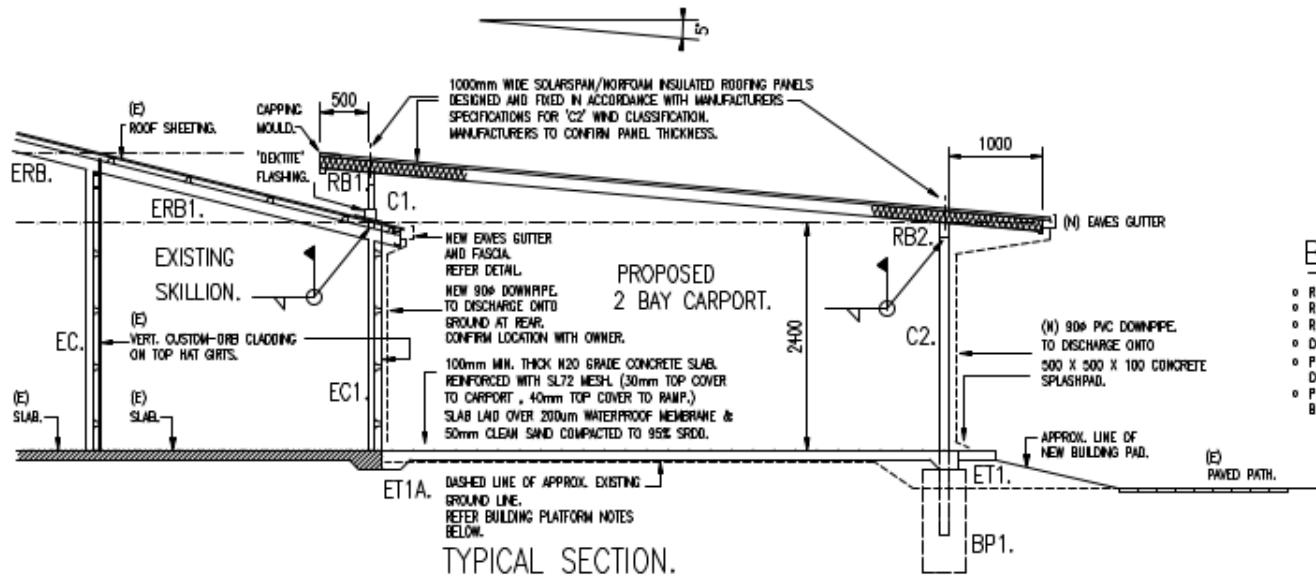

TYPICAL SECTION.

SCALE :- 1:50

BUILDING PAD PREPARATION NOTES.

- REMOVE LARGE ROCKS...OVER 150#
- REMOVE ORGANIC MATTER TO WITHIN 150 OF SURFACE.
- REMOVE LOOSE MATERIAL (WITHIN 400mm OF SURFACE)
- COMPACT REMAINING BASE MATERIAL TO 95% SRDD.
- PROVIDE APPROVED FILL MATERIAL IN 150mm LAYERS COMPACTED TO 95% SRDD. (WITH OPTIMUM MOISTURE CONTENT)
- PROPOSED COMPACTED BUILDING PLATFORM TO EXTEND 500mm BEYOND PROPOSED BUILDING LINES.

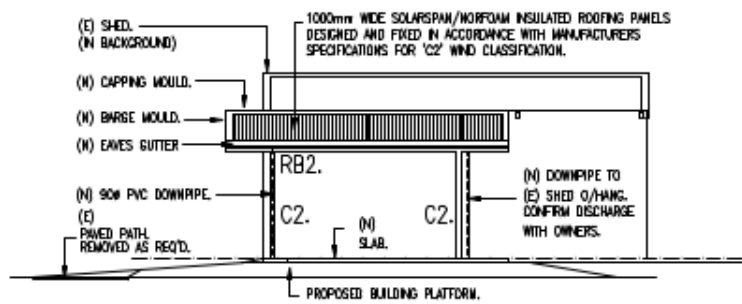

SIDE ELEVATION.

SCALE :- 1:100

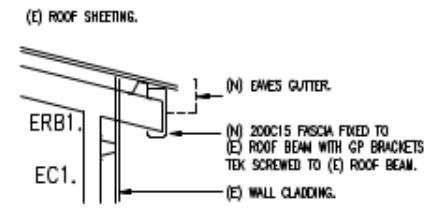

SECTION, SCALE :- 1:20  
NEW EAVES GUTTER TO EXISTING SHED.

WE CERTIFY THE STRUCTURAL DETAILS AS SHOWN ON THESE DRAWINGS FOR CONSTRUCTION IN WIND CLASSIFICATION C2

*[Signature]* 16-3-26

**C.M.G. CONSULTING ENGINEERS** (Pty) Ltd  
ACN 011 065 375

208 BUCHAN ST  
CAIRNS Q 4870  
PH 07 4031 2775  
cmg@cmgengineers.com.au

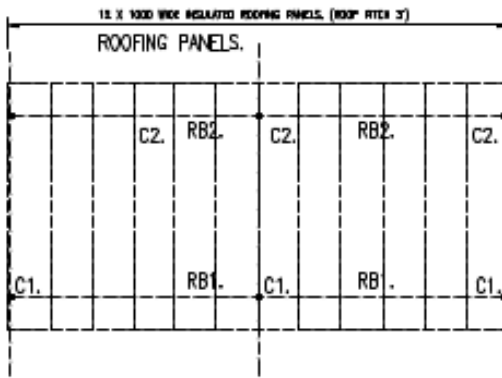

ROOF FRAMING PLAN, SCALE 1:100

ROOF FRAMING SCHEDULE.

- C1. 100 X 100 X 4.0 SHS COLUMNS. (HIGH SIDE)
- C2. 100 X 100 X 4.0 SHS COLUMNS. (LOW SIDE)
- RB1. 150 X 100 X 4.0 RHS ROOF BEAM. (HIGH SIDE)  
CFW AXP C1 COLUMNS, CONTINUOUS WITH 6 END PLATES  
OR  
150 X 100 X 5.0 RHS ROOF BEAM. (HIGH SIDE)  
CFW AXP C1 COLUMNS, CONTINUOUS WITH 6 END PLATES  
BEAM JOINED OVER CENTRE COLUMN.
- RB2. 150 X 100 X 4.0 RHS ROOF BEAM. (LOW SIDE)  
CFW AXP C1 COLUMNS, CONTINUOUS WITH 6 END PLATES  
OR  
150 X 100 X 5.0 RHS ROOF BEAM. (LOW SIDE)  
CFW AXP C1 COLUMNS, CONTINUOUS WITH 6 END PLATES  
BEAM JOINED OVER CENTRE COLUMN.

ROOFING PANELS.

SOLARSPAN/VERIFORM INSULATED ROOFING PANELS 1000mm WIDE  
FIXED TO RHS ROOF BEAMS TO MANUFACTURERS SPECIFICATIONS  
FOR 'C2' WIND CLASSIFICATION.

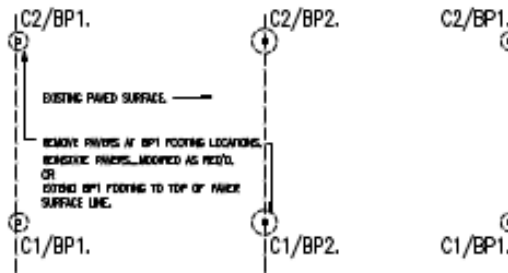

FOOTING PLAN.

SCALE 1:100

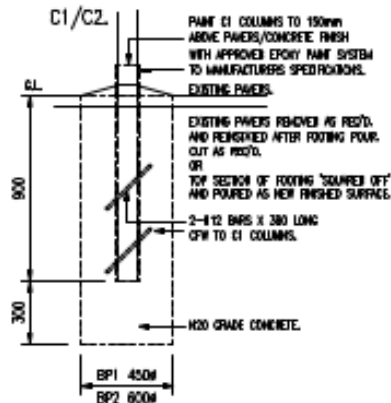

BP1 & BP2 DETAIL.

SCALE 1:20

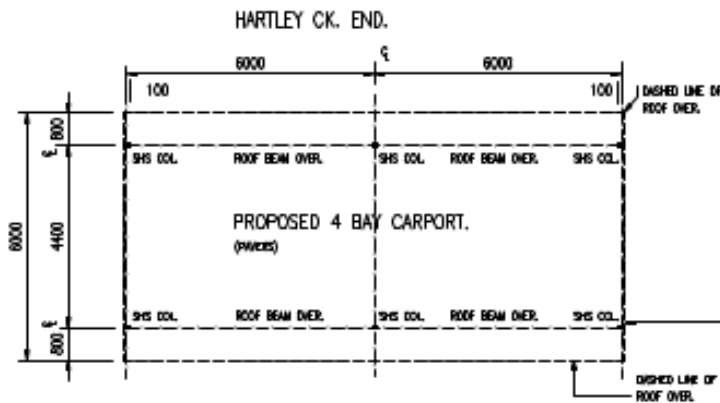

FLOOR PLAN.

SCALE 1:100

WE CERTIFY THE STRUCTURAL DETAILS  
AS SHOWN ON THESE DRAWINGS FOR  
CONCRETE IN WIND CLASSIFICATION C2

*[Signature]* 16-3-26

**C.M.G.** CONSULTING ENGINEERS (PTY) LTD  
208 BUCHAN ST  
CARINGB. Q. 4870  
PH: 07 4624 2775  
www.cmgengineers.com.au

SOLARSPAN/HORROCK INSULATED ROOFING PANELS 1000mm WIDE  
 FIXED TO RIB ROOF BEAMS TO MANUFACTURERS SPECIFICATIONS  
 FOR 'C2' WIND CLASSIFICATION.  
 SUPPLIER TO CONFIRM PANEL THICKNESS.

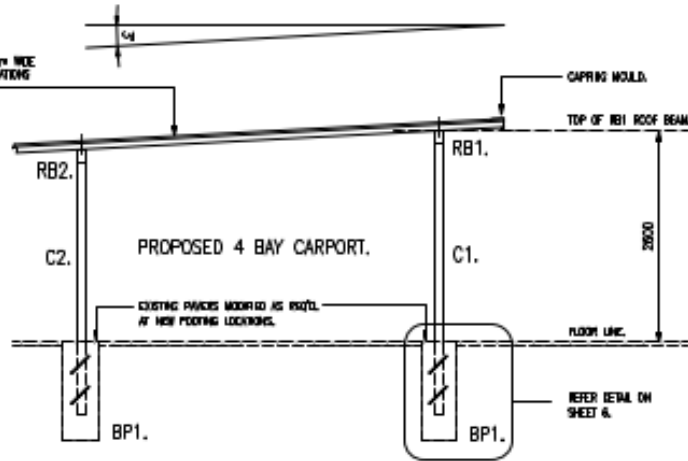

TYPICAL SECTION. SCALE 1:100

SOLARSPAN/HORROCK INSULATED ROOFING PANELS 1000mm WIDE  
 FIXED TO RIB ROOF BEAMS TO MANUFACTURERS SPECIFICATIONS  
 FOR 'C2' WIND CLASSIFICATION.  
 SUPPLIER TO CONFIRM PANEL THICKNESS.

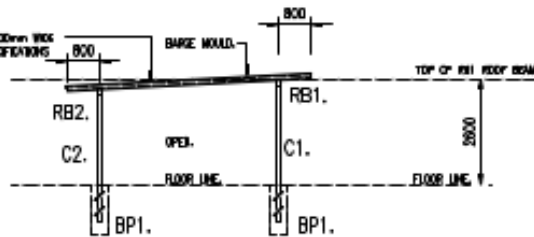

SOUTH-EAST ELEVATION. SCALE 1:100  
 NORTH-WEST ELEVATION SIMILAR.

WE CERTIFY THE STRUCTURAL DETAILS  
 AS SHOWN ON THESE DRAWINGS FOR  
 CONFORMANCE WITH WIND CLASSIFICATION C2

*[Signature]*

**C.M.G. CONSULTING ENGINEERS** PTY LTD  
 15-3-25  
 188 BUCHANAN ST  
 CARINGBURN Q 4870  
 PH 07 4831 2775  
 Email: cmg@cmgconsulting.com.au  
 ACRN 911 988 275

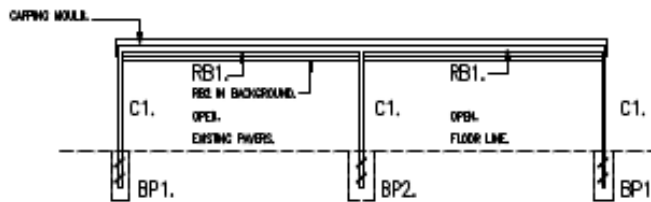

SOUTH-WEST ELEVATION. SCALE 1:100  
 FRONT ELEVATION. FROM DRIVE IN

SOLARSPAN/HORROCK INSULATED ROOFING PANELS 1000mm WIDE  
 FIXED TO RIB ROOF BEAMS TO MANUFACTURERS SPECIFICATIONS  
 FOR 'C2' WIND CLASSIFICATION.  
 SUPPLIER TO CONFIRM PANEL THICKNESS.

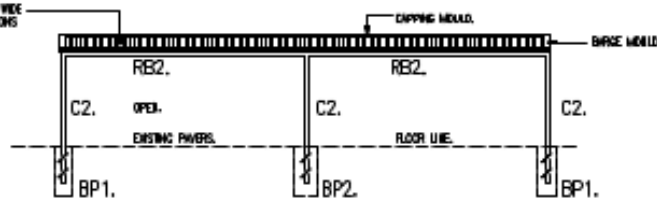

NORTH-EAST ELEVATION. SCALE 1:100  
 REAR ELEVATION. FROM HARTLEY'S DRIVE

## Reasons for Decision

1. The reasons for this decision are:
  - a. Sections 60, 62 and 63 of the *Planning Act 2016*;
  - b. to ensure the development satisfies the benchmarks of the 2018 Douglas Shire Planning Scheme Version 1.0; and
  - c. to ensure compliance with the *Planning Act 2016*.
2. Findings on material questions of fact:
  - a. the development application was properly lodged to the Douglas Shire Council 28/03/2026 under section 51 of the *Planning Act 2016* and Part 1 of the *Development Assessment Rules*;
  - b. the development application contained information from the applicant which Council reviewed together with Council's own assessment against the 2017 State Planning Policy and the 2018 Douglas Shire Planning Scheme Version 1.0 in making its assessment manager decision.
3. Evidence or other material on which findings were based:
  - a. the development triggered assessable development under the Assessment Table associated with the Environmental Management Zone Code;
  - b. Council undertook an assessment in accordance with the provisions of sections 60, 62 and 63 of the *Planning Act 2016*; and
  - c. the applicant's reasons have been considered and the following findings are made:
    - i. Subject to conditions, the development satisfactorily meets the Planning Scheme benchmarks.

*relevant preliminary approval* means a preliminary approval given under the old Act by an entity other than a private certifier.

## **Division 2            Changing development approvals**

### **Subdivision 1        Changes during appeal period**

#### **74        What this subdivision is about**

- (1) This subdivision is about changing a development approval before the applicant's appeal period for the approval ends.
- (2) This subdivision also applies to an approval of a change application, other than a change application for a minor change to a development approval.
- (3) For subsection (2), sections 75 and 76 apply—
  - (a) as if a reference in section 75 to a development approval were a reference to an approval of a change application; and
  - (b) as if a reference in the sections to the assessment manager were a reference to the responsible entity; and
  - (c) as if a reference in section 76 to a development application were a reference to a change application; and
  - (d) as if the reference in section 76(3)(b) to section 63(2) and (3) were a reference to section 83(4); and
  - (e) with any other necessary changes.

#### **75        Making change representations**

- (1) The applicant may make representations (*change representations*) to the assessment manager, during the applicant's appeal period for the development approval, about changing—

- 
- (a) a matter in the development approval, other than—
    - (i) a matter stated because of a referral agency's response; or
    - (ii) a development condition imposed under a direction given by the Minister under part 6, division 2; or
    - (iii) a development condition imposed under a direction given by the chief executive under section 106ZF(2); or
  - (b) if the development approval is a deemed approval—the standard conditions taken to be included in the deemed approval under section 64(8)(d).
- (2) If the applicant needs more time to make the change representations, the applicant may, during the applicant's appeal period for the approval, suspend the appeal period by a notice given to the assessment manager.
- (3) Only 1 notice may be given.
- (4) If a notice is given, the appeal period is suspended—
- (a) if the change representations are not made within a period of 20 business days after the notice is given to the assessment manager—until the end of that period; or
  - (b) if the change representations are made within 20 business days after the notice is given to the assessment manager, until—
    - (i) the applicant withdraws the notice, by giving another notice to the assessment manager; or
    - (ii) the assessment manager gives the applicant the decision notice for the change representations; or
    - (iii) the end of 20 business days after the change representations are made, or a longer period agreed in writing between the applicant and the assessment manager.
- (5) If the applicant makes the change representations during the appeal period without giving a notice under subsection (2),

the appeal period is suspended from the day the representations are made until—

- (a) the applicant withdraws the change representations by notice given to the assessment manager; or
  - (b) the assessment manager gives the applicant the decision notice for the change representations; or
  - (c) the end of 20 business days after the change representations are made, or a longer period agreed in writing between the applicant and the assessment manager.
- (6) Despite subsections (4) and (5), if the decision notice mentioned in subsection (4)(b)(ii) or (5)(b) is a negotiated decision notice, the appeal period starts again on the day after the negotiated decision notice is given.

## **76 Deciding change representations**

- (1) The assessment manager must assess the change representations against and having regard to the matters that must be considered when assessing a development application, to the extent those matters are relevant.

*Note—*

For change representations for a development approval for development requiring social impact assessment, see also section 106ZI.

- (2) The assessment manager must, within 5 business days after deciding the change representations, give a decision notice to—
- (a) the applicant; and
  - (b) if the assessment manager agrees with any of the change representations—
    - (i) each principal submitter; and
    - (ii) each referral agency; and
    - (iii) if the assessment manager is not a local government and the development is in a local

- 
- government area—the relevant local government;  
and
- (iv) if the assessment manager is a chosen assessment manager—the prescribed assessment manager; and
  - (v) another person prescribed by regulation.
- (3) A decision notice (a *negotiated decision notice*) that states the assessment manager agrees with a change representation must—
- (a) state the nature of the change agreed to; and
  - (b) comply with section 63(2) and (3).
- (4) A negotiated decision notice replaces the decision notice for the development application.
- (5) Only 1 negotiated decision notice may be given.
- (6) If a negotiated decision notice is given to an applicant, a local government may give a replacement infrastructure charges notice to the applicant.

## Subdivision 2 Changes after appeal period

### 77 What this subdivision is about

This subdivision is about changing a development approval, other than the currency period, after all appeal periods in relation to the approval end.

### 78 Making change application

- (1) A person may make an application (a *change application*) to change a development approval.

*Note—*

For the making of a change application for a development approval that was a PDA development approval, see also the *Economic Development Act 2012*, sections 51AM, 51AN and 51AO.

- (2) The person is taken to have engaged in the representative's conduct, unless the person proves the person could not have prevented the conduct by exercising reasonable diligence.
- (3) In this section—
  - conduct** means an act or omission.
  - representative** means—
    - (a) of a corporation—an executive officer, employee or agent of the corporation; or
    - (b) of an individual—an employee or agent of the individual.
  - state of mind**, of a person, includes the person's—
    - (a) knowledge, intention, opinion, belief or purpose; and
    - (b) reasons for the intention, opinion, belief or purpose.

## Chapter 6 Dispute resolution

### Part 1 Appeal rights

#### 229 Appeals to tribunal or P&E Court

- (1) Schedule 1 states—
  - (a) matters that may be appealed to—
    - (i) either a tribunal or the P&E Court; or
    - (ii) only a tribunal; or
    - (iii) only the P&E Court; and
  - (b) the person—
    - (i) who may appeal a matter (the *appellant*); and
    - (ii) who is a respondent in an appeal of the matter; and

- (iii) who is a co-respondent in an appeal of the matter;  
and
- (iv) who may elect to be a co-respondent in an appeal of the matter.

*Note—*

For limitations on appeal rights in relation to a development approval for development requiring social impact assessment, see section 106ZJ.

- (2) An appellant may start an appeal within the appeal period.
- (3) The *appeal period* is—
  - (a) for an appeal by a building advisory agency—10 business days after a decision notice for the decision is given to the agency; or
  - (b) for an appeal against a deemed refusal—at any time after the deemed refusal happens; or
  - (c) for an appeal against a decision of the Minister, under chapter 7, part 4, to register premises or to renew the registration of premises—20 business days after a notice is published under section 269(3)(a) or (4); or
  - (d) for an appeal against a decision of the Minister, under chapter 7, part 4, to amend the registration of premises to include additional land in the affected area for the premises—20 business days after the day a notice is published under section 269A(2)(a); or
  - (e) for an appeal against an infrastructure charges notice—20 business days after the infrastructure charges notice is given to the person; or
  - (f) for an appeal about a deemed approval of a development application for which a decision notice has not been given—30 business days after the applicant gives the deemed approval notice to the assessment manager; or
  - (g) for an appeal relating to the *Plumbing and Drainage Act 2018*—
    - (i) for an appeal against an enforcement notice given because of a belief mentioned in the *Plumbing and*

*Drainage Act 2018*, section 143(2)(a)(i), (b) or (c)—5 business days after the day the notice is given; or

- (ii) for an appeal against a decision of a local government or an inspector to give an action notice under the *Plumbing and Drainage Act 2018*—5 business days after the notice is given; or
  - (iii) for an appeal against a failure to make a decision about an application or other matter under the *Plumbing and Drainage Act 2018*—at anytime after the period within which the application or matter was required to be decided ends; or
  - (iv) otherwise—20 business days after the day the notice is given; or
- (h) for any other appeal—20 business days after a notice of the decision for the matter, including an enforcement notice, is given to the person.

*Note—*

See the P&E Court Act for the court's power to extend the appeal period.

- (4) Each respondent and co-respondent for an appeal may be heard in the appeal.
- (5) If an appeal is only about a referral agency's response, the assessment manager may apply to the tribunal or P&E Court to withdraw from the appeal.
- (6) To remove any doubt, it is declared that an appeal against an infrastructure charges notice must not be about—
  - (a) the adopted charge itself; or
  - (b) for a decision about an offset or refund—
    - (i) the establishment cost of trunk infrastructure identified in a LGIP; or
    - (ii) the cost of infrastructure decided using the method included in the local government's charges resolution.

---

**230 Notice of appeal**

- (1) An appellant starts an appeal by lodging, with the registrar of the tribunal or P&E Court, a notice of appeal that—
  - (a) is in the approved form; and
  - (b) succinctly states the grounds of the appeal.
- (2) The notice of appeal must be accompanied by the required fee.
- (3) The appellant or, for an appeal to a tribunal, the registrar, must, within the service period, give a copy of the notice of appeal to—
  - (a) the respondent for the appeal; and
  - (b) each co-respondent for the appeal; and
  - (c) for an appeal about a development application under schedule 1, section 1, table 1, item 1—each principal submitter for the application whose submission has not been withdrawn; and
  - (d) for an appeal about a change application under schedule 1, section 1, table 1, item 2—each principal submitter for the application whose submission has not been withdrawn; and
  - (e) each person who may elect to be a co-respondent for the appeal other than an eligible submitter for a development application or change application the subject of the appeal; and
  - (f) for an appeal to the P&E Court—the chief executive; and
  - (g) for an appeal to a tribunal under another Act—any other person who the registrar considers appropriate.
- (4) The *service period* is—
  - (a) if a submitter or advice agency started the appeal in the P&E Court—2 business days after the appeal is started; or
  - (b) otherwise—10 business days after the appeal is started.

- (5) A notice of appeal given to a person who may elect to be a co-respondent must state the effect of subsection (6).
- (6) A person elects to be a co-respondent to an appeal by filing a notice of election in the approved form—
  - (a) if a copy of the notice of appeal is given to the person—within 10 business days after the copy is given to the person; or
  - (b) otherwise—within 15 business days after the notice of appeal is lodged with the registrar of the tribunal or the P&E Court.
- (7) Despite any other Act or rules of court to the contrary, a copy of a notice of appeal may be given to the chief executive by emailing the copy to the chief executive at the email address stated on the department's website for this purpose.

### 231 Non-appealable decisions and matters

- (1) Subject to this chapter, section 316(2), schedule 1 and the P&E Court Act, unless the Supreme Court decides a decision or other matter under this Act is affected by jurisdictional error, the decision or matter is non-appealable.
- (2) The *Judicial Review Act 1991*, part 5 applies to the decision or matter to the extent it is affected by jurisdictional error.
- (3) A person who, but for subsection (1) could have made an application under the *Judicial Review Act 1991* in relation to the decision or matter, may apply under part 4 of that Act for a statement of reasons in relation to the decision or matter.
- (4) In this section—

**decision** includes—

  - (a) conduct engaged in for the purpose of making a decision; and
  - (b) other conduct that relates to the making of a decision; and

- 
- (c) the making of a decision or the failure to make a decision; and
  - (d) a purported decision; and
  - (e) a deemed refusal.

**non-appealable**, for a decision or matter, means the decision or matter—

- (a) is final and conclusive; and
- (b) may not be challenged, appealed against, reviewed, quashed, set aside or called into question in any other way under the *Judicial Review Act 1991* or otherwise, whether by the Supreme Court, another court, any tribunal or another entity; and
- (c) is not subject to any declaratory, injunctive or other order of the Supreme Court, another court, any tribunal or another entity on any ground.

## **232 Rules of the P&E Court**

- (1) A person who is appealing to the P&E Court must comply with the rules of the court that apply to the appeal.
- (2) However, the P&E Court may hear and decide an appeal even if the person has not complied with rules of the P&E Court.

# **Part 2 Development tribunal**

## **Division 1 General**

### **233 Appointment of referees**

- (1) The Minister, or chief executive, (the **appointer**) may appoint a person to be a referee, by an appointment notice, if the appointer considers the person—